

Empfohlene Pflegeprodukte
Produits d'entretien recommandés
Recommended care products
Suositellut hoitotuotteet



HEISSNER CLEAN
ZP9001-00



biologisch abbaubar
frei von Chlor + Essig

BRUNNENREINIGER
FOUNTAIN CLEANER | NETTOYEUR DE FONTAINE

PUMPENREINIGER
PUMP CLEANER | NETTOYANT POMPE

LAMPENREINIGER
LAMP CLEANER | NETTOYANT POUR LAMPE

FILTERREINIGER
FILTER CLEANER | NETTOYANT FILTRE

Spezialreiniger & Entkalker
für Laufeinheiten, UVC-Gläser,
Lampen und Brunnen

Special cleaner & descaler for running units,
UVC glasses, lamps and fountains

Nettoyant spécial et décalcifiant pour
pompes, filtres et lampes

Verlängert die Lebenszeit von Pumpen
Extends the life of pumps • Prolonge la vie des pompes

Für Geräte an Teichen, Brunnen, Pools und Aquarien
For devices on ponds, fountains, pools and aquariums
Pour l'équipement dans les bassins, les puits, les piscines et les
aquariums

Erhöht die Effizienz von UVC-Klärern
Increases the efficiency of UVC clarifiers
Augmente l'efficacité des clarificateurs UVC

DE AT CH LV HR UA HEISSNER GmbH · Schlitzer Straße 24
D-36341 Lauterbach · Germany
Tel. +49 66 41-86 555 · Fax +49 66 41-86 299
www.heissner.de · info@heissner.de

FR ES Aqualux · 287 Avenue de la Massane · 13210 Saint Rémy de Provence
France · Tel. : +33 978 03 02 60 · sav@aqualux.com · www.aqualux.com

IT PET TRIBE SRL · Vicolo Chiodo 5 · I-37138 Verona · Italy
Tel. +39 045 8101566 · Fax +39 045 8101630 · info@pettribe.com
www.pettribe.it

FI Horisont Enterprises Ltd Oy · Malminkartanonkuja 4 · FI-00390 Helsinki ·
Finland · Tel. +358 (0)9 6866 720 · office@horisontenterprises.fi
www.horisontenterprises.fi

NO Fernando Norge AS · Aslakveien 14 E · NO-0753 Oslo · Norway
Tel. +47 9118 2885 · lbj@fernando.no

RO Chemoform Romania SRL · Strada Garii No 714R · RO-137090 Ciocanesti,
Judetul Dambovita · Romania · Tel. 004 021 242 05 94
Fax 004 021 242 00 61 · office@chemoform.ro · www.chemoform.ro

BG Aqua Cor & Co Ltd. · Angista Street 8 · 1527 Sofia · Bulgaria
Tel. +359 2 943 41 08 · Fax +359 8 93 66 82 64 · aqua.cor@market.bg ·
www.aqua-cor.com

PL Chemoform Polska Sp. z o.o. · ul. Gacka 1 · PL-41 218 Sosnowiec · Poland
Tel. +48 32 297 71 38 · Fax +48 32 291 97 07 · info@chemoform.pl
www.chemoform.pl

HU Diatahun Kft. · Szabadsag Str. 114 · HU-8790 Zalaszentgot · Hungary
Tel. +36 30 84 13 639 · diatakft@gmail.com

GR TECHNIKI - ATHINON AFOI ATHANASIADIS O.E. · Kalymnoy 2 · GR-15121
PEFKI-Athens · Greece · Tel. +30 210 619 66 90 · Fax +30 210 619 67 27
techniki-athinon@otenet.gr · www.techniki-athinon.gr

RU 000 Chemoform Russia · Pos. Mosrentgen · RUS-119017 Moscow · Russia
Tel: +7 800 707 19 77 · Tel.: +7 495 980 80 22 · info@chemoform.ru
www.chemoform.ru

LT UAB Horticom · Zirmunu g. 66 · Vilnius LT-09131 · Lithuania
Tel: +370 5 27 37 026 · Fax: +370 5 27 22 902 · vilnius@horticom.lt
www.horticom.lt

EE Horticom OÜ · Loomäe tee 11 · Rae tehnopark · EE-75306 Lehmja, Rae Vald
Harjumaa · Estonia · Tel: +372 65 12 950 · Fax: +372 65 12 970
info@horticom.ee · www.horticom.ee

TR Fluidra · 1 No lu Caddes no 3 · TR-34953 Tuzla (Istanbul) · Turkey
Tel. +90 543 535 37 34 · info@fluidra.com.tr · www.fluidra.com.tr

GB Certikin International Ltd · Unit 4, Tungsten Park · Witney / Oxon OX29 0AX
Great Britain · Tel. +44 (0) 1993 778 855 · Fax +44 (0) 1993 778 620
enquiries@certikin.co.uk · www.certikin.co.uk

BA SL Ursula Alibester · Selca 2 · 4227 Selca · Slovenia
Tel. +386 (0) 31 265 228 · ursula.alibester@gmail.com

NL BE ALPC · Icarus 11 · NL-8448 CJ Heerenveen · Netherlands
Tel. +31 513 41 28 12 · Tel. service: +31 513 62 66 66
verkoop@alpc.nl · service@alpc.nl · www.alpc.nl

DK SE Fernando Aps · Klokkestøber vej 12 · DK-8800 Viborg · Denmark
Tel. +45 86 62 34 46 · Fax +45 86 62 34 51
kundeservice@fernandoaps.dk · www.fernandoaps.dk

CZ SK ZC s.r.o. · Jiráskovo předměstí 633/III · CZ-37701 Jindřichův Hradec
Czech Republic · Tel. +420 384 370 900 · vo@zc.cz · www.zc.cz

3dG · 10-2022

Betriebsanleitung

Instructions for use
Mode d'emploi
Bedrijfshandleiding
Manual de funcionamiento
Istruzioni per l'uso
Betjeningsvejledning
Användarhandledning
Bruksanvisning
Instrucțiuni de utilizare
Керівництво з експлуатації
Käyttöohje
Navodila za uporabo
Návod na prevádzku
Návod k použití
Használati útmutató
Instrukcja obsługi
Upute za rad
Инструкция по эксплуатации
İşletim talimatı
Kasutusjuhend
Инструкция за работа
Manual de instruções
Lietošanas instrukcija
Naudojimo instrukcija
操作说明书



VIDEO ANLEITUNG
+ Installation
+ Bedienung
+ Wartung
www.heissner.de/service/videos



HFP10000-00

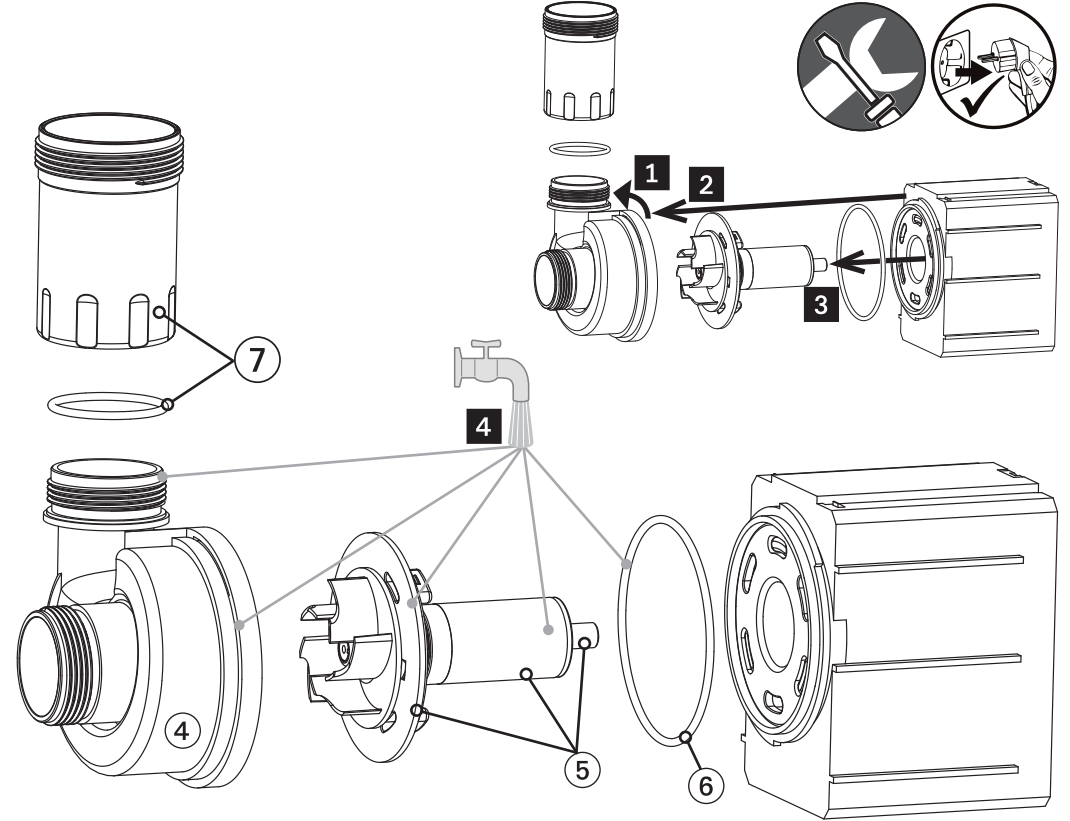
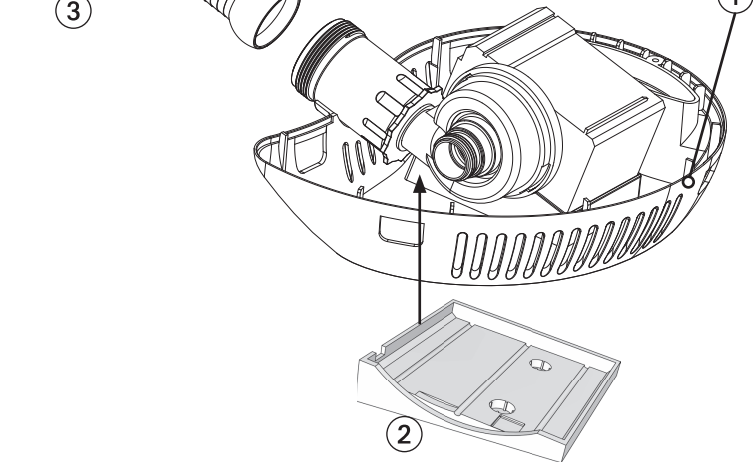
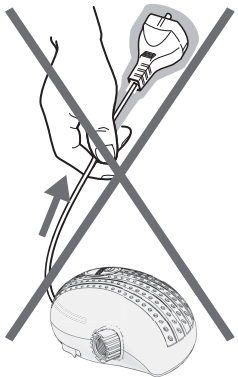
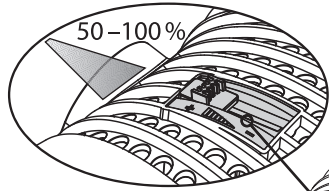
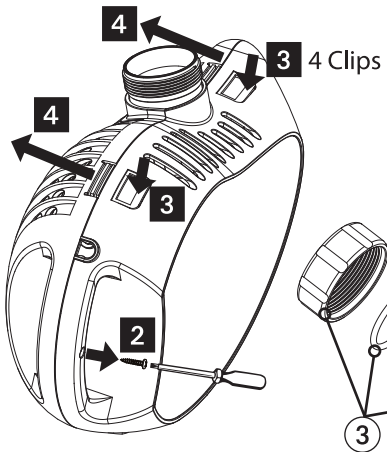
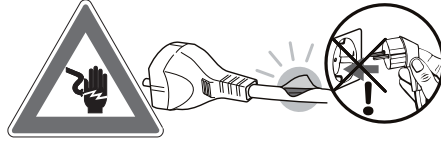
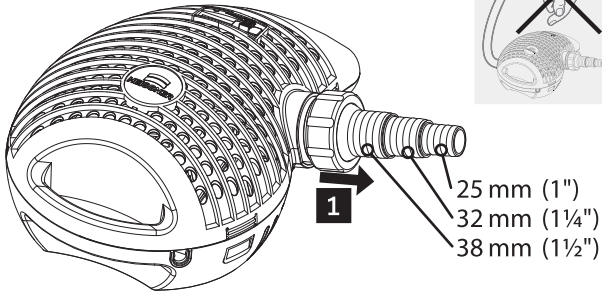
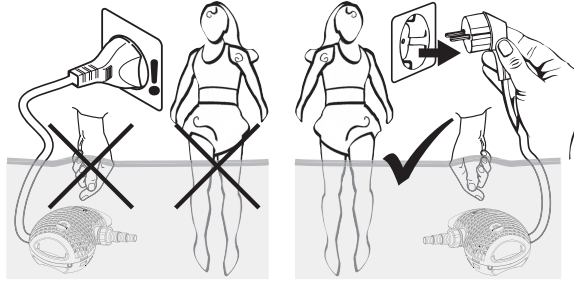
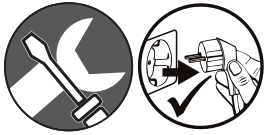

AC 230V/50Hz
95 W
IP X8

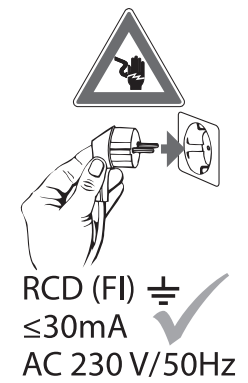
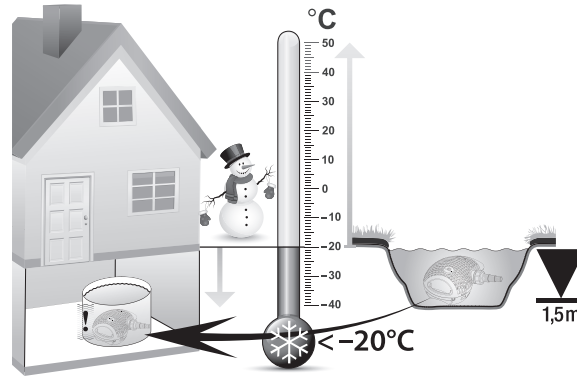
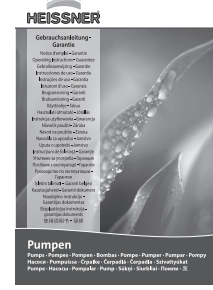
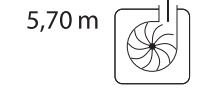
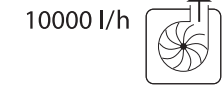

	①	②	③
HFP10000-00	ET32-P0070	ET12-P10EG	ET12-Z4990

	④	⑤	⑥	⑦
HFP10000-00	ET12-P10EB	ZP102E-00	ET12-P10EA	ET12-P70EF